



Viton- Steckverschraubungen

Push-in fittings

Raccordi automatici

Raccords instantanés



Druckring Metall

Thrust ring
Anello spingitore
Bague poussoir

Gehäuse aus Messing

Oberfläche vernickelt
Nickel-plated brass body
Corpo di ottone nickelato
Corps en laiton nickelé

O-Ringe aus Viton

Viton O-Ring
O-R in Viton
Bague O R en Viton

Spannzange aus Edelstahl

Stainless clamp
Pinza in acciaio inox.
Pince en acier inox.

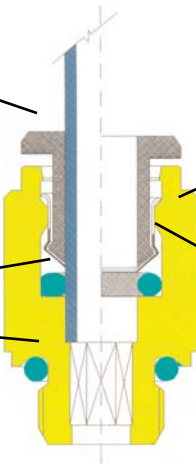

Technische Daten für steckverschraubungen

Serie *ipso* Viton

Toleranz für Polyamid-Schlauch PA11/12

Rohr-Außen-Ø	Toleranz des Außen-Ø	
4 - 8mm	+0,1	-0,1
10 - 22mm	+0,15	-0,15

Toleranz für Polyamid-Schlauch PU

Rohr-Außen-Ø	Toleranz des Außen-Ø	
4 - 8mm	+0,1	-0,1
10 - 14mm	+0,15	-0,1

Technische Daten:

Betriebstemperatur : -20°C +150°C
geeigneteMedien : Druckluft, alle flüssigen und gasförmigen Medien, die mit den Werkstoffen der Komponenten kompatibel sind.
Vakuum : max.98%
Werkstoff : Gehäuse aus Ms58, vernickelt
: Dichtungen aus Viton
: Spannzange aus Edelstahl AISI316
: Druckring aus Messing vernickelt
Gewinde : zylindrisch BSPP mit O-Ringabdichtung Viton

Anwendungsgebiete:

für alle flüssigen und gasförmigen Medien die mit diesen Bestandteilen kompatibel sind, z.B. Kalt- und Warmwasser, Dampf, Fette und Öle, Industrieabwässer. Für Vakuum geeignet.



Technical data for push-in fittings

in the *ipso* -Series-Viton

Tolerances for PA11 and PA12 pipes (Polyamide)

Outside pipe diameter	Outside pipe diameter tolerance	
4 - 8mm	+0,1	-0,1
10 - 22mm	+0,15	-0,15

Tolerances for Polyurethane (PU) pipes

Outside pipe diameter	Outside pipe diameter tolerance	
4 - 8mm	+0,1	-0,1
10 - 14mm	+0,15	-0,1

Technical data:

Working temperature : -20°C +150°C
Fluid : Compressed air (other fluids on request)
Vakuum : max.98%
Material : 58 nickel-plated brass
: Silicone-free Viton gaskets
: AISI 316 stainless steel clamp
: Metal- Ring
Threading : parallel BSPP with O-Ring Viton seal
Fields of application : for all liquid and gas media, which are compatible with the various fitting components i.e.: cold + hot water, steam, greases and oils, industrial liquids. Vacuum-compatible.

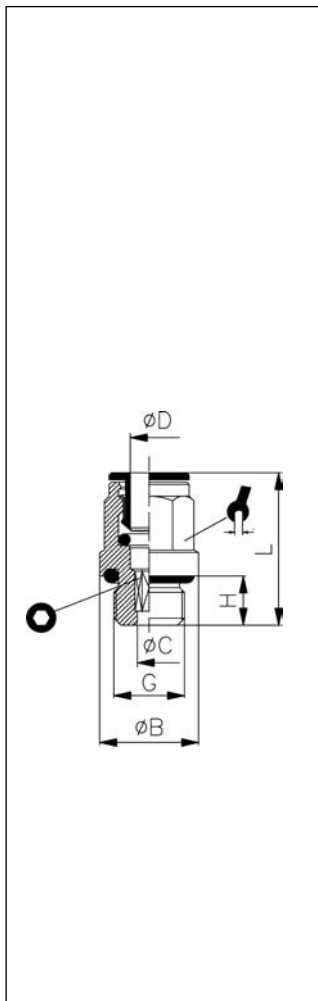

ipso 01-Viton

gerade Einschraubverschraubung

Straight male adaptor (parallel)

Diritto filetto cilindrico maschio con O-Ring

Piquage droit mâle cylindriqueipso

	ØD	G	ØC	ØB	H	L			
v200101	4	M5	2,6	9,0	4,0	20,5	Ø9	2,5	50
v200102	4	G ^{1/8}	2,6	13,5	6,0	20,0	9	2,5	50
v200103	4	G ^{1/4}	2,6	17,0	8,0	21,0	9	2,5	50
v200100	6	M5	2,6	10,5	4,0	22,5	Ø10,5	2,5	50
v200107	6	G ^{1/8}	4,2	13,5	6,0	24,0	11	4	50
v200108	6	G ^{1/4}	5,0	17,0	8,0	24,0	11	4	50
v200109	8	G ^{1/8}	5,0	13,0	6,0	26,5	13	5	50
v200110	8	G ^{1/4}	6,2	17,0	8,0	25,0	13	6	50
v200111	8	G ^{3/8}	6,2	20,0	9,0	25,0	13	6	50
v200112	10	G ^{1/4}	7,3	16,0	8,0	29,5	16	7	50
v200113	10	G ^{3/8}	8,3	21,0	9,0	29,5	16	8	50

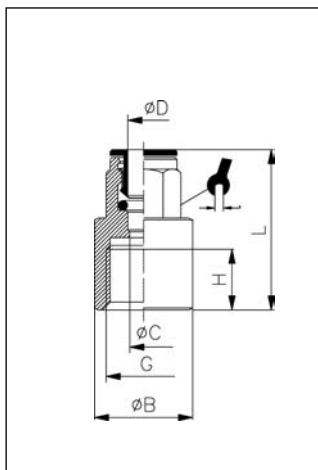

ipso 02-Viton

Manometerverschraubung

Straight female adaptor

Diritto femmina

Piquage droit femelle

	ØD	G	ØC	ØB	H	L		
v200201	4	G ^{1/8}	3,0	11,0	6,0	26,5	9	50
v200205	6	G ^{1/8}	5,0	11,0	6,0	27,0	11	50
v200206	6	G ^{1/4}	5,0	16,0	13,0	31,0	11	50
v200207	8	G ^{1/8}	7,0	11,0	6,0	28,0	13	50
v200208	8	G ^{1/4}	7,0	16,0	13,0	32,0	13	50

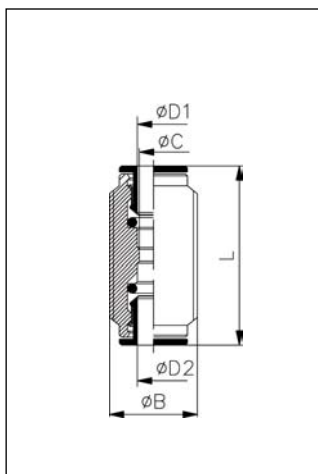

ipso 03-Viton

gerader Verbinder

Straight connector

Intermedio

Union double

	ØD1	ØD2	ØC	ØB	L	
v200301	4	4	3,0	10	32,0	50
v200303	6	6	5,0	14	33,5	50
v200304	8	8	7,0	16	37,0	50
v200305	10	10	9,0	17	39,5	50

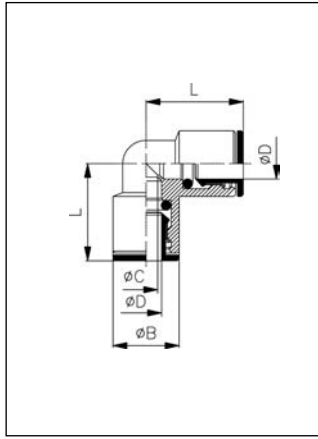

ipso 04-Viton

Winkerverbinder
Elbow connector
Gomito innestabile
Equerre égale

	ØD	ØC	ØB	L	
v200401	4	3,0	9,0	17,5	50
v200403	6	5,0	11,0	19,5	50
v200404	8	7,0	13,0	23,0	50
v200405	10	8,0	15,0	25,0	50

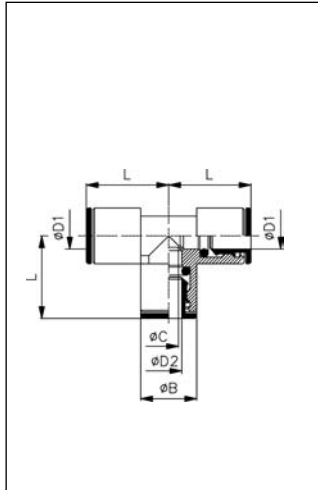

ipso 05-Viton

T-Verbinder
Tee connector
T innestabile
Té égal

	ØD1	ØD2	ØC	ØB	L	
v200501	4	4	3,0	9,0	17,5	50
v200503	6	6	5,0	11,0	19,5	50
v200504	8	8	7,0	13,0	23,0	50
v200505	10	10	8,0	15,0	25,0	20

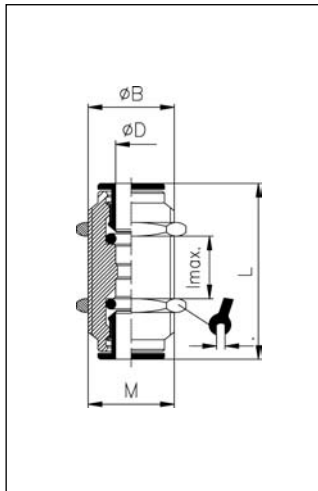

ipso 010-Viton

Schottverschraubung
Bulkhead connector
Passaparete
Traversée de cloison

	ØD	LW	M	imax	L	
v201101	4	3,0	M10x1	8	32,0	13 50
v201103	6	5,0	M14x1	8	33,5	17 50
v201104	8	7,0	M16x1	10	37,0	18 50
v201105	10	9,0	M17x1	12	39,5	20 25

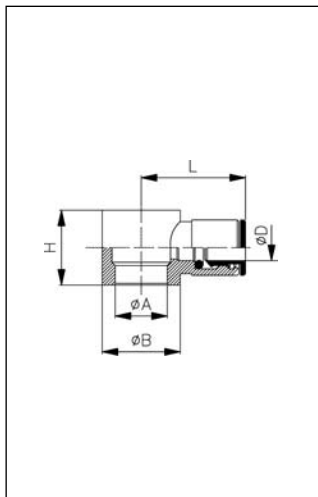

ipso 013-Viton

Ringstück 1-fach
Single banjo body
Anello semplice
Corps de banjo simple

	ØD	G	ØA	ØB	H	L	
v201201	4	M5	5,0	SW9	9,0	19,0	50
v201202	4	G ¹ / ₈	9,9	14	15,0	21,0	50
v201205	6	G ¹ / ₈	9,9	14	15,0	23,0	50
v201206	6	G ¹ / ₄	13,3	18	17,0	24,0	50
v201207	8	G ¹ / ₄	9,9	14	15,0	24,5	50
v201208	8	G ¹ / ₄	13,3	18	17,0	26,0	50
v201210	10	G ¹ / ₄	13,3	18	17,0	27,0	50
v201211	10	G ³ / ₈	16,6	21	20,0	29,0	25

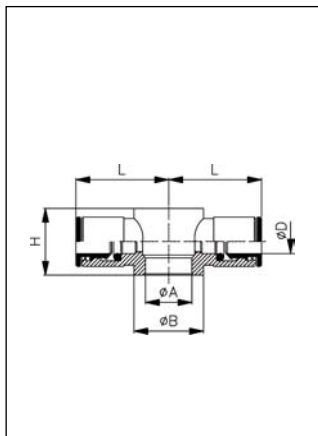

ipso 014-Viton

Ringstück 2-fach
 Double banjo body
Anello doppio
 Corps de banjo double

	ØD	G	ØA	ØB	H	L		
201302	4	G ¹ / ₈	9,9	14	15,0	21,0		50
201305	6	G ¹ / ₈	9,9	14	15,0	23,0		50
201306	6	G ¹ / ₄	13,3	18	17,0	24,0		50

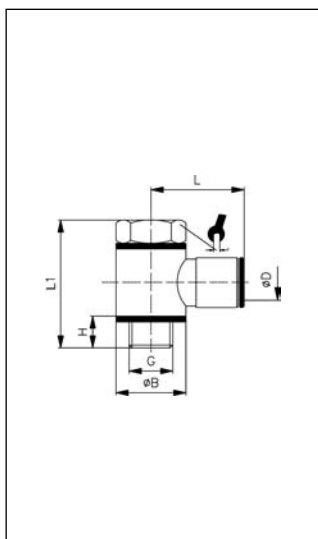

ipso 017-Viton

Winkelschwenkverschraubung
 Complete single swivel banjo
Orientabile semplice asta con filetto cilindrico
 Vis + corps de banjo simple

	ØD	G	ØB	H	L1	L		
v11201	4	M5	SW9	4,05	17,5	18,5	8	50
v11202	4	G ¹ / ₈	14	7,5	28,0	21,0	14	50
v11203	5	M5	SW9	4,5	17,5	19,5	87	50
v11213	6	M5	SW9	4,5	17,5	19,0	8	50
v11205	6	G ¹ / ₈	14	7,5	28,0	22,5	14	50
v11206	6	G ¹ / ₄	18	9,0	33,0	24,0	17	50
v11207	8	G ¹ / ₈	14	7,5	28,0	24,5	14	25
v11208	8	G ¹ / ₄	18	9,0	33,0	26,0	17	25
v11209	8	G ³ / ₈	21	10,0	37,0	28,0	22	25
v11210	10	G ¹ / ₄	18	9,0	33,0	27,0	17	25
v11212	12	G ³ / ₈	21	10,0	37,0	30,0	22	10

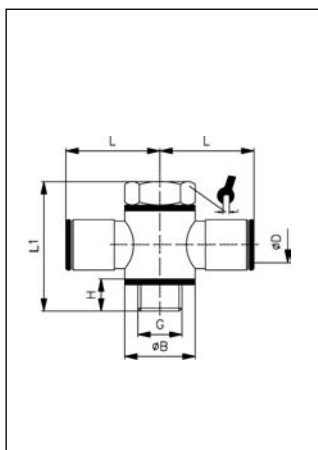
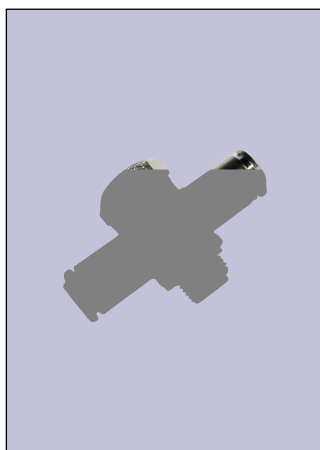

ipso 018-Viton

T-Schwenkverschraubung
 Complete double swivel banjo
Orientabile doppio asta con filetto cilindrico
 Vis + corps de banjo double

	ØD	G	ØB	H	L1	L		
v11302	4	G ¹ / ₈	14	7,5	28,0	21,0	14	50
v11305	6	G ¹ / ₈	14	7,5	28,0	22,5	14	50
v11306	6	G ¹ / ₄	18	9,0	33,0	24,0	17	50

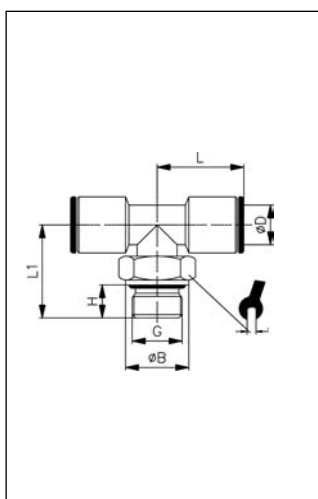

ipso 020-Viton

T-Verschraubung drehbar
 Rotary tee parallel adaptor
Raccordo a T girevole
 Té centre mâle orientable

	ØD1	G	ØB	H	L1	L2		
v202001	4	G ¹ / ₈	13,0	6,0	17,5	18,5	13	100
v202003	6	G ¹ / ₈	13,0	6,0	21,0	18,5	13	100
v202005	8	G ¹ / ₈	13,0	6,0	23,0	20,5	13	100
v202006	8	G ¹ / ₄	16,0	8,0	23,0	22,5	16	100
v202008	10	G ¹ / ₄	16,0	8,0	25,5	24,5	16	50

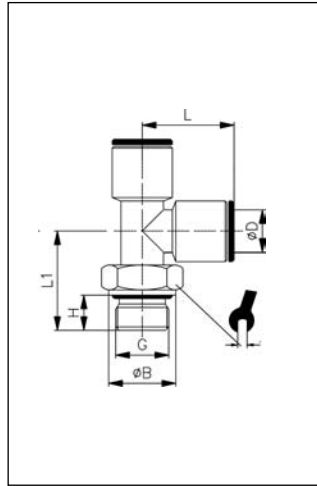

ipso 021-Viton

L-Verschraubung drehbar

Rotary parallel male L-adaptor

Raccordo a L- girevole

L centre mâle orientable

	ØD	G	ØB	H	L	L1		
v202101	4	G ^{1/8}	13,0	6,0	17,5	18,5	13	100
v202103	6	G ^{1/8}	13,0	6,0	19,5	18,5	13	100
v202104	6	G ^{1/4}	16,0	8,0	21,0	22,5	16	100
v202105	8	G ^{1/8}	13,0	6,0	23,0	20,5	13	100
v202106	8	G ^{1/4}	16,0	8,0	23,0	22,5	16	100
v202108	10	G ^{1/4}	16,0	8,0	25,5	24,5	16	50

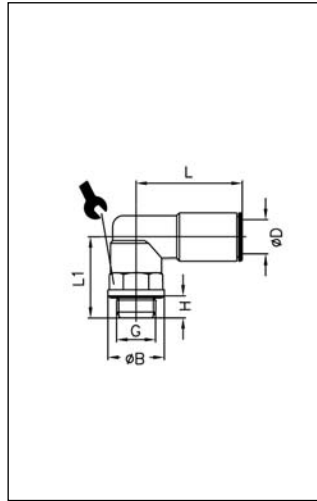

ipso 022-Viton

Winkelschraubung drehbar

Rotary elbow male adaptor parallel

Gomito girevole filetto cilindrico maschio con O-Ring

Equerre piquage mâle orientable cylindrique

	ØD	G	ØB	H	L	L1		
v202200	4	M5	8,0	4,0	19,0	14,5	9	100
v202201	4	G ^{1/8}	13,0	8,0	19,0	20,0	13	100
v202203	6	G ^{1/8}	13,0	6,0	21,0	20,0	13	100
v202204	6	G ^{1/4}	16,0	8,0	21,0	24,0	13	100
v202205	8	G ^{1/8}	13,0	6,0	24,0	20,0	13	100
v202206	8	G ^{1/4}	16,0	8,0	24,0	24,0	13	100
v202207	8	G ^{3/8}	20,0	9,0	24,0	25,5	13	50
v202208	10	G ^{1/4}	16,0	8,0	27,0	24,0	14	50
v202209	10	G ^{3/8}	20,0	9,0	27,0	28,0	16	50